

EDITION 2023

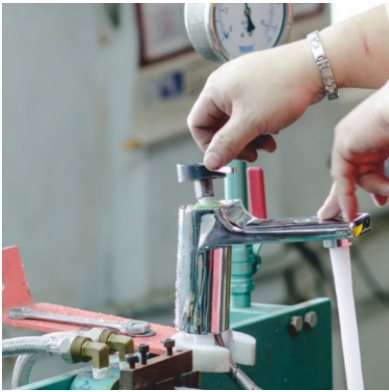

M.K.G.



## TECHNOLOGY

- CASTING
- MOULDING
- TURNING
- ELECTRO PLATING
- CNC
- POLISHING
- ASSEMBLING
- WATER TESTING
- APPEARANCE OF QUALITY
- PACKAGING

# CONTENTS

<b>HEALTH FAUCETS</b>	<b>1-2</b>
<b>HEALTH FAUCETS SET</b>	<b>3-5</b>
<b>SHOWER TUBES &amp; CONNECTIONS</b>	<b>6</b>
<b>SOFT CLOSE SEAT COVERS</b>	<b>7-9</b>
<b>SHOWERS &amp; ARM</b>	<b>10</b>
<b>CISTERN FITTINGS</b>	<b>11</b>
<b>CISTERN BALL COCK</b>	<b>12</b>
<b>CISTERN FITTING BUTTON</b>	<b>13</b>
<b>CONCEALED RODS</b>	<b>14</b>
<b>WC CONNECTORS</b>	<b>15</b>
<b>HINGES</b>	<b>16-18</b>
<b>ALLIED ITEMS</b>	<b>19-20</b>

*Health Faucets*





SEI-HF-01 SHELL CUT



SEI-HF-02 MARK



SEI-HF-03 RONDA



SEI-HF-04 HOLE



SEI-HF-05 DELUXE



SEI-HF-07 CONTI



SEI-HF-08 SLEEK



SEI-HF-09 CURVE



SEI-HF-10 JAQ



SEI-HF-12	GRO
-----------	-----



SEI-HF-14	DOLPHIN
-----------	---------



SEI-HF-17	HEXA
-----------	------



SEI-HF-18	H/W
-----------	-----



SEI-HF-19	MAHINDRA
-----------	----------



SEI-HF-01	<b>SHELL CUT</b>
A,C-1mtr	B,D-1.5mtr



SEI-HF-02	<b>MARK</b>
A,C-1mtr	B,D-1.5mtr



SEI-HF-03	<b>RONDA</b>
A,C-1mtr	B,D-1.5mtr



SEI-HF-04	<b>HOLE</b>
A,C-1mtr	B,D-1.5mtr



SEI-HF-05	<b>DELUXE</b>
A,C-1mtr	B,D-1.5mtr

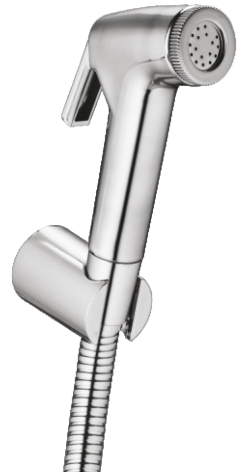

SEI-HF-07	<b>CONTI</b>
A,C-1mtr	B,D-1.5mtr



SEI-HF-08	<b>SLEEK</b>
A,C-1mtr	B,D-1.5mtr



SEI-HF-09	<b>CURVE</b>
A,C-1mtr	B,D-1.5mtr



SEI-HF-10	<b>JAQ</b>
A,C-1mtr	B,D-1.5mtr



SEI-HF-12	<b>GRO</b>
A,C-1mtr	B,D-1.5mtr



SEI-HF-14	<b>DOLPHIN</b>
A,C-1mtr	B,D-1.5mtr



SEI-HF-17	<b>HEXA</b>
A,C-1mtr	B,D-1.5mtr





SEI-HF-18	H/W
A,C-1mtr	B,D-1.5mtr



SEI-HF-19	MAHINDRA
A,C-1mtr	B,D-1.5mtr



SEI-H-01	ABS HOOK
----------	----------



SEI-ML-01	MIXER LEG PAR
Size : 18" , 24" , 30" , 36"	



SEI-ML-02	MIXER LEG JAQ
Size : 18" , 24"	



SEI-ST-01	SPIRAL
A-1mtr , B-1.5mtr	



SEI-C-01	SS 304 16 OD
Size : 12" , 18" , 24" , 30" , 36" , 48" , 60"	

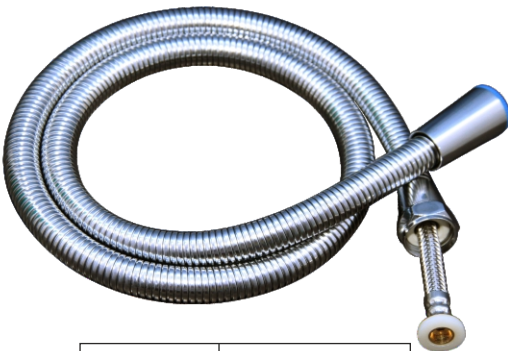

SEI-ST-02	PULL OUT
C-1mtr , D-1.5mtr	



SEI-C-02	SS 304 18 OD
Size : 12" , 18" , 24" , 30" , 36" , 48" , 60"	



*Soft Close  
Seat Covers*





SEI-SC-01	SUN
Size : 16.5"x13.25"	



SEI-SC-02	VENUS
Size : 18"x14.5"	



Also Available in  
 Sliding Top Fixing



SEI-SC-03	EWC
Size : 16"x14"	



SEI-SC-04	MYSTERY
Size : 16.5"x13.25"	



SEI-SC-05 | ENIGMA

Size : 17.5"x13.25"



SEI-SC-06 | CASCADE

Size : 17"x15"

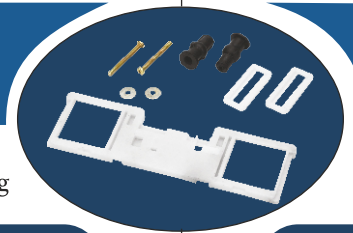

Also Available in  
 Sliding Top Fixing



SEI-SC-07 | ITALIAN

Size : 18"x13.75"



SEI-SC-08 | MARINA

Size : 17.25"x13.75"



SEI-SC-09

EWC



SEI-SC-12

CASCADE



SEI-SC-13

ANGLO INDIAN

## SHOWERS & ARM



SEI-OHS-1	<b>ULTRA THIN</b>
Size : 4",6",8",10",12",16",24"	



SEI-OHS-2	<b>MAZE</b>
Size : 4",6",8",10",12",16",24"	



SEI-OHS-03	<b>OPEL</b>
Size : 4",6",8",10",12",16",24"	



SEI-ARM-01	<b>ARM</b>
Size : 9",12", 15",18", 24"	



SEI-CF-01	R H/W
Size : 6" , 8" , 10" , 12"	



**GANPATI PRINT & PACKAGING**

SEI-CF-02	R H/W THREADED
Size : 6" , 8" , 10" , 12"	



SEI-CF-03	CASCADE
Size : 58mm , 65mm	





SEI-CF-04A	R H/W
------------	-------



SEI-CF-04B	LITE
------------	------

GANPATI PRINT & PACKAGING



SEI-CF-05	INLET VALVE
-----------	-------------

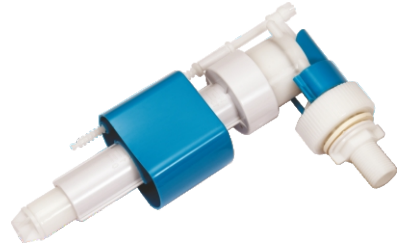

SEI-CF-06	CONCEALED
Size : 1/2"	

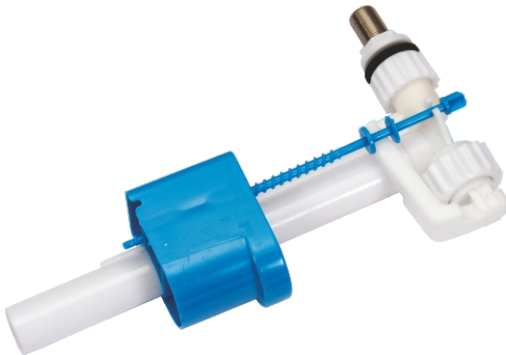

SEI-CF-07	CONCEALED
Size : 1/2" x 3 Soot	

**CISTERN FITTING BUTTON**



SEI-CF-08A | ONE PIECE LONG ROD



SEI-CF-08B | CASCADE BIG



SEI-CF-08C | CASCADE SMALL



SEI-CF-08D | CASCADE CHURI

**CISTERN**



SEI-CF-08E | CENTER PUSH



SEI-CF-09 | CLASSIC



SEI-CR-01A	01 No.
------------	--------



SEI-CR-01B	02 No.
------------	--------



SEI-CR-01C	03 No.
------------	--------



SEI-CR-01D	04 No.
------------	--------



SEI-CR-01E	05 No.
------------	--------



SEI-CR-01F	06 No.
------------	--------



SEI-CR-01G	07 No.
------------	--------



SEI-WCC-01A	WC CONNECTOR
Size : 6x4"	



SEI-WCC-01B	BEND
Size : 4"	



SEI-WCC-01C	LONG
Size : 5"	



SEI-WCC-01D	CONNECTOR
Size : 12"	



SEI-WCC-01E	FLEXIBLE
Size : 12"	



SEI-WCC-01F	LONG
Size : 90mm	



SEI-WCC-01G	CNCLD. PIPE
Size : 9"	



SEI-WCC-01H	CNCLD. PIPE
Size : 12"	

*\*Also Available in Silicon Washer*

# Hinges

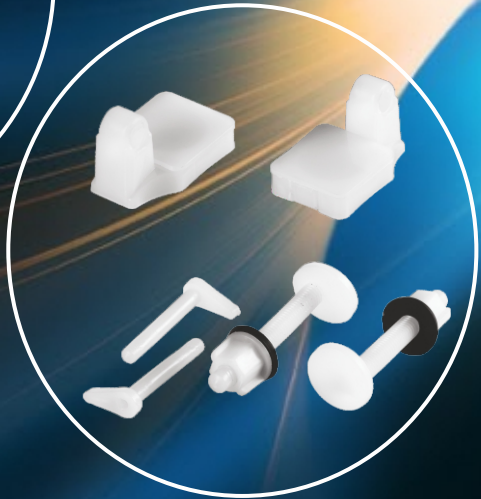
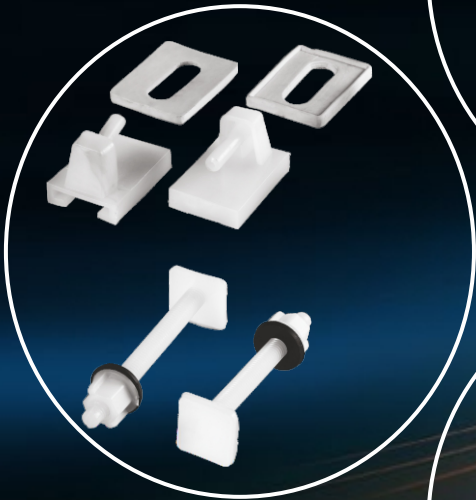



**SEI-SCH-01A | FASTNER**



**SEI-SCH-01B | TOPI FASTNER**



**SEI-SCH-01C | BK FASTNER**

**GANPATI PRINT & PACKAGING**



**SEI-SCH-02 | HINDWARE**

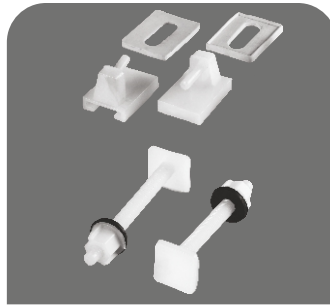

**SEI-SCH-03 | DIBBY SET (H)**

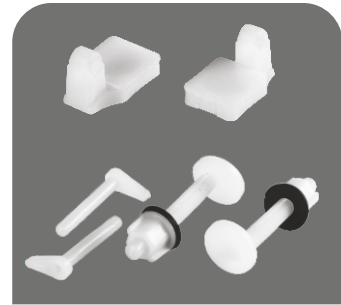

**SEI-SCH-04 | DIPLOMAT**

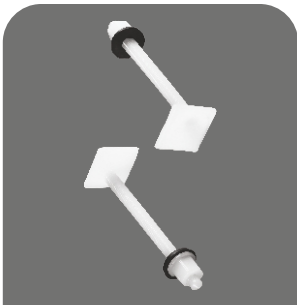

**SEI-SCH-05A | SUPER BIG**  
 Size : 42mm



**SEI-SCH-05B | CHINA MEDIUM**  
 Size : 42mm



**SEI-SCH-05C | CHINA BIG**  
 Size : 48mm



SEI-SCH-05D	CHINA 4
Size : 58mm	

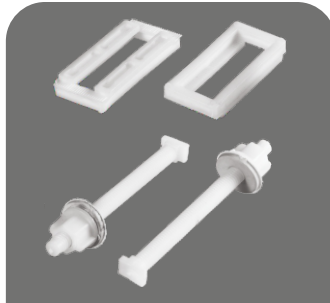

SEI-SCH-05E	CHINA 5
Size : 62mm	



SEI-SCH-05F	CHINA
Size : 65mm	



SEI-SCH-06A	L/R
-------------	-----



SEI-SCH-06B	LEFT INDIA
-------------	------------

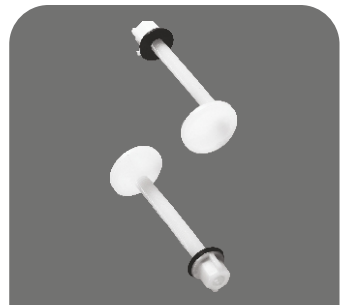

SEI-SCH-07A	SUPER GOL
Size : 38mm	

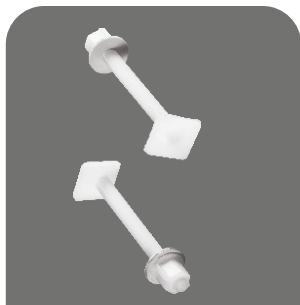

SEI-SCH-07B	SUPER CHINA BIG
Size : 38mm	



SEI-SCH-07C	CHINA SMALL
Size : 38mm	

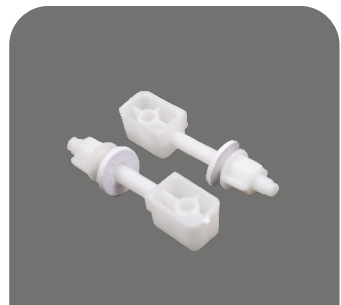

SEI-SCH-08A	CERA
-------------	------

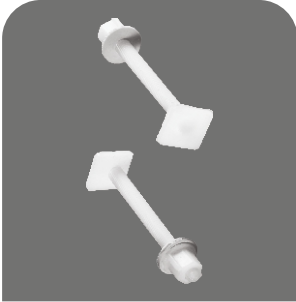

SEI-SCH-8B ITALIAN



SEI-SCH-09 DIBBY SET (L)



SEI-SCH-10 CASCADE



SEI-SCH-11 L-TYPE

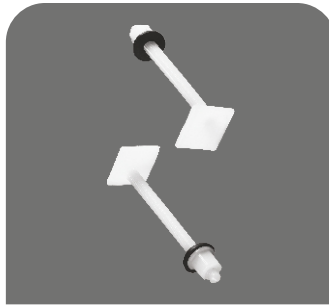

SEI-SCH-12B ITALIAN

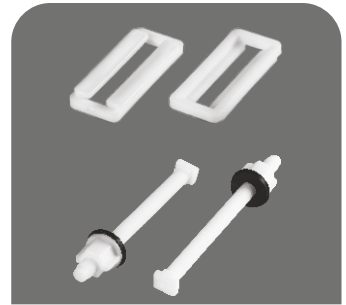

SEI-SCH-18 HINGES

Size : 45mm

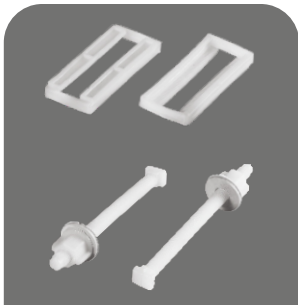

SEI-SCH-19 HINGES

Size : 50mm



SEI-SCH-20

QQ

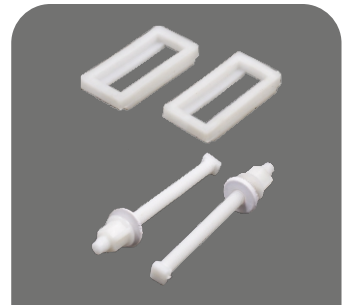

SEI-SCH-21 ONE PIECE

Size : 52mm





SEI-J-01	<b>MULTI</b>
A-1mtr , B-1.5mtr	



SEI-J-02	<b>AMERICAN</b>
A-1mtr , B-1.5mtr	



SEI-J-03	<b>REGULAR</b>
A-1mtr , B-1.5mtr	



SEI-FJ-01	<b>BIDDING</b>
Size : 4" , 5"	



SEI-FJ-02	<b>HOLE BIDDING</b>
Size : 4" , 5"	



SEI-FJ-03	<b>LOCKING</b>
Size : 5"	



SEI-FJ-04	<b>COCKROACH</b>
Size : 5"	



SEI-W-01	<b>BASKET WASTE</b>
----------	---------------------



SEI-W-02	<b>SS WASTE</b>
Size : 3", 5", 7", 9", 12"	

SEI-W-03	<b>BRASS WASTE</b>
Size : 3", 5", 7", 9", 12"	

SEI-W-04	<b>POP-UP</b>
Size : 3", 5", 7"	



SEI-AI-01	<b>EXTENSION NIPPLE</b>
Size : 1", 1-1/2", 2", 2.5", 3", 4", 6"	

SEI-AI-02	<b>BOTTLE TRAP</b>
-----------	--------------------

SEI-AI-03	<b>HAND DRYER</b>
-----------	-------------------



SEI-AI-04	<b>2 PIN FASTNER</b>
MS & SS	

SEI-AI-05	<b>WC BOLT SS</b>
-----------	-------------------

*Notes...*



M.K.G.

Mktd. By :

**Sheemah Enterprises (INDIA)**

Hauz Qazi, Delhi-110006

E-mail : [info@mkghub.com](mailto:info@mkghub.com)

[www.mkghub.com](http://www.mkghub.com)



# printganti@gmail.com # 9711847059